



Creating Space for New Technology



SmartCart *PRODUCT GUIDE*

tbconsoles.com



Equipment Carts – Overview

STANDARD SERIES

12ru mobile equipment rack. Available in 1-bay, 1.5-bay, and 2-bay configurations. Standard features include ergonomic thermofoil worksurface with embedded device track, vented + removable rear door, heavy duty casters, and front and rear rack rail. (see page 3).



'N' SERIES NESTED

12ru mobile equipment rack. Available in 1-bay, and 1.5-bay configurations. Also available in a Producer's side table. The worksurface contour "nests" with the desktop profile of SmartTrac consoles. Standard features include ergonomic thermofoil worksurface with embedded device track, heavy duty casters, and front and rear rack rail. (see page 3).

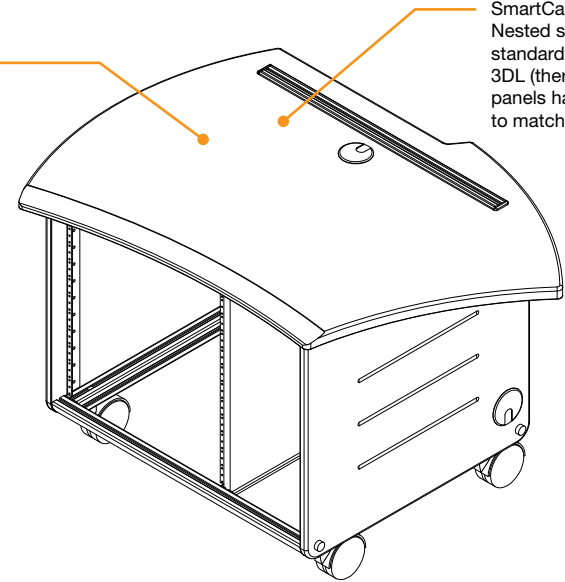

SmartCart Standard and Nested series cart tops come standard with a Shark Grey 3DL (thermofoil) finish. The side panels have a silver 3DL finish to match the console leg.

'V' SERIES VERTICAL

1-Bay mobile equipment rack available in 15, 18, and 24ru configurations. Benefits of vertical configuration include; efficient use of floor space with compact footprint, and allows for equipment at seated eye level in taller versions. Standard features include Thermofoil side panels, vented + removable rear panel, rear device track, heavy duty casters, and front and rear rack rail. (see page 3).



SmartCart Vertical Series side panels come standard with a Shark Grey 3DL (thermofoil) finish.

Acrylic finish upgrade



Optional Rack-mount locking drawers for storage, available in 2 - 8 RU sizes.

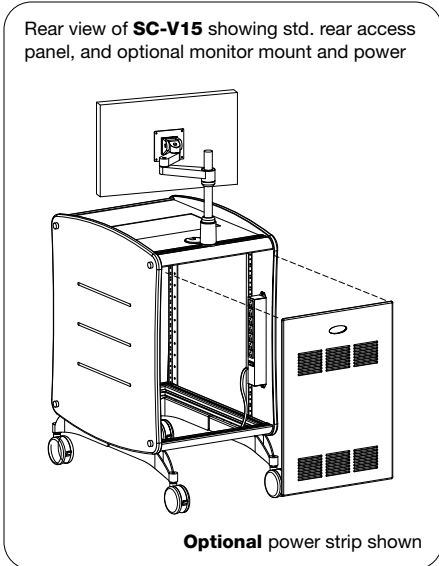

Rear view of SC-V15 showing std. rear access panel, and optional monitor mount and power

Optional power strip shown



Standard Series Carts

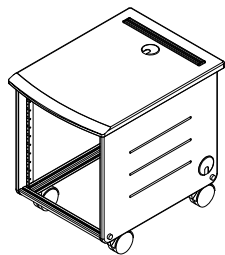

SC-1
1-bay x 12ru mobile equipment rack

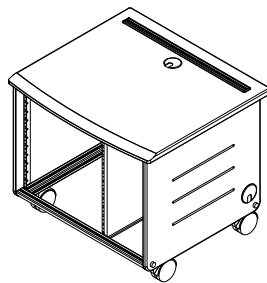

SC1.5-L
1.5-bay x 12ru mobile equipment rack with CPU cubby. (Rack left, CPU right)

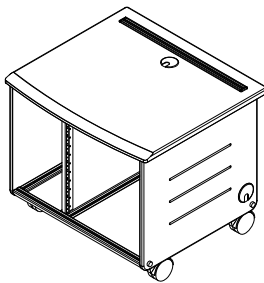

SC1.5-R
1.5-bay x 12ru mobile equipment rack with CPU cubby. (Rack right, CPU left)

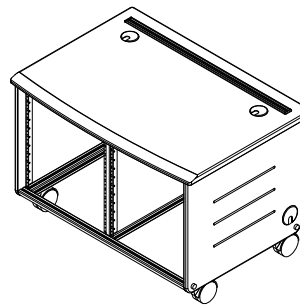

SC-2
2-bay x 12ru mobile equipment rack (24ru total)

Producer Tables



SC-PTR shown
Also available with a tear drop shape base for additional stability.



SC-PTL
Producer's table, w/rear trac Nests on left side of console



SC-PTL
Producer's table, w/rear trac Nests on right side of console

'N' Series Nested Carts



SC1-NR shown



SC1-NL
1-bay x 12ru mobile equipment rack Nests on left side of console



SC1-NR
1-bay x 12ru mobile equipment rack Nests on left side of console



SC1.5-NR shown



SC1.5-NL
1.5-bay x 12ru mobile equipment rack Nests on left side of console. (CPU right)



SC1.5-NR
1.5-bay x 12ru mobile equipment rack Nests on left side of console. (CPU left)

'V' Series Vertical Carts

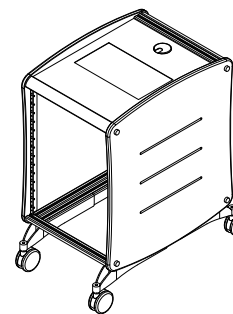

SC-V15
15ru mobile equipment rack

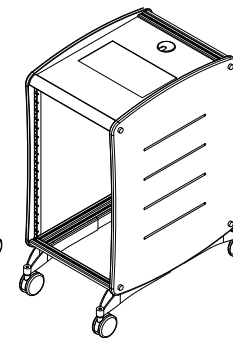

SC-V18
18ru mobile equipment rack

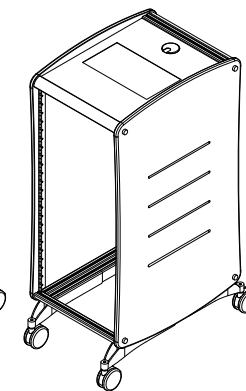

SC-V24
24ru mobile equipment rack

Heavy Duty Carts



Custom Carts available to meet equipment needs.

SmartCart Accessories

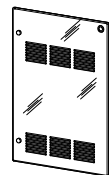

SC1-PD
Hinged vented smoked Plexi door, 1 bay cart.

SC1.5-PD
Hinged vented smoked Plexi door, 1.5 bay cart.

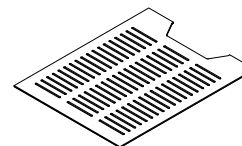

SC1-VB
Vented black HDPE bottom closure pane, 1 bay cart.

SC1.5-VB
Vented black HDPE bottom closure pane, 1 bay cart.

PS-0815-ET
Power strip, 8 outlets, 15amp, Mounts to interior of cart side panel.





Finishes

The standard finish for TBC consoles includes a selection from any of the below plastic laminate or linoleum colors. The below samples represent color suggestions we have found to be more functional than others in the video production environment. They are more subdued with low light reflection, and would finish the horizontal surfaces of your console. The base cabinets and body of the console would be black laminate, unless you prefer another color that compliments the countertop selection.

Finishes that do come with an additional premium include, “designer” laminates such as textured metals, Corian® & equivalents, solid woods, wood veneers and acrylic.

LAMINATE

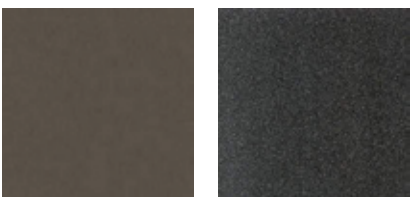

Shale Graphite Nebula

LINOLEUM

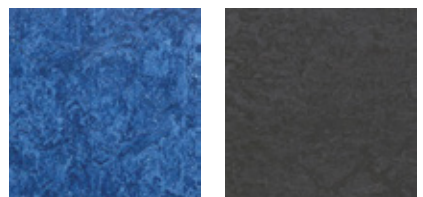

Blue Slate Grey

SOLID SURFACE

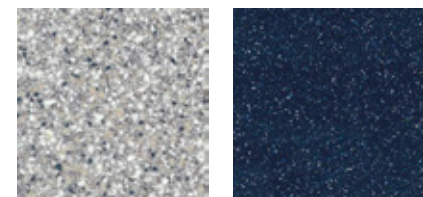

Platinum Cobalt

ACRYLIC (PLEXI)

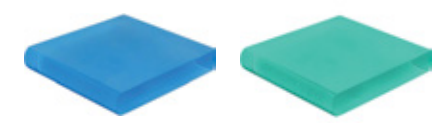

Blue Green

3DL THERMOFOIL SIDE PANELS



(side panels stocked in Shark Grey, Platinum Silver, and Matte Black)

ADDITIONAL ACCESSORIES AND COMPANION CONSOLES

